

GAS AND PARTICULATE REMOVAL BY XCAPER
PERSONAL SMOKE MASK – XSMO3

Prepared by:

Riley N. Kinman, Ph.D., P.E.

September 2008

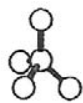

RNK Environmental, Inc.
2643 Crescent Springs Road
Erlanger, Kentucky 41017-1504

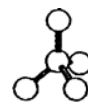

TABLE OF CONTENTS

EXECUTIVE SUMMARY.....iii

1. INTRODUCTION 1

2. SPECIFIC OBJECTIVES..... 1

3. TEST APPARATUS..... 2

4. RESULTS OF GAS AND PARTICULATE REMOVAL TESTING..... 8

5. PROCEDURES AND RESULTS FOR PHYSICAL TESTING 13

6. DISCUSSION 17

7. SUMMARY..... 18

LIST OF TABLES

Table 1: TYPE AND COMPOSITION OF SMOKE MASK TESTED

Table 2: MEAN PERCENT REMOVALS FOR 10 PPM ACROLEIN

Table 3: MEAN PERCENT REMOVALS FOR 100 PPM ACROLEIN

Table 4: MEAN PERCENT REMOVALS FOR 1,000 PPM HYDROGEN CHLORIDE

Table 5: MEAN PERCENT REMOVALS FOR 400 PPM HYDROGEN CYANIDE

Table 6: MEAN PERCENT REMOVALS FOR 2,500 PPM CARBON MONOXIDE

Table 7: MEAN PERCENT REMOVALS FOR 0.3 μm PARTICULATES AT 30×10^9 PARTICLES PER CUBIC METER

Table 8: MEAN PERCENT REMOVALS FOR ALL TESTS

LIST OF FIGURES

Figure 1: TEST APPARATUS SCHEMATIC DIAGRAM

Figure 2: SMOKE MASK MOUNTED ON HUMAN HEAD SIMULATOR INSIDE PLEXIGLASS GLOVE BOX

Figure 3: TEST APPARATUS SETUP WITH HEAD, GLOVE BOX, AND HOSPITAL VENTILATORS

Figure 4: PREPARING FOR TESTING BY CONNECTING MONITORING INSTRUMENT TO SAMPLE LINE

Figure 5: MASSAGING A SMOKE MASK DURING ACTIVE TEST

**GAS AND PARTICULATE REMOVAL BY XCAPER
PERSONAL SMOKE MASK – XSMO3**

Executive Summary

Prepared by:

Riley N. Kinman, Ph.D., P.E.

September 2008

**RNK Environmental, Inc.
2643 Crescent Springs Road
Erlanger, Kentucky 41017-1504**

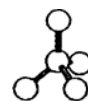
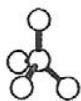

EXECUTIVE SUMMARY
TABLE OF CONTENTS

I. INTRODUCTION.....v
II. SPECIFIC OBJECTIVES.....v
III. RESULTS.....viii
IV. BRIEF DISCUSSION.....viii
V. SUMMARY.....viii

EXECUTIVE SUMMARY
LIST OF TABLES

Table A. Mean Percent Removals for All Tests, Gases, and Particulates

EXECUTIVE SUMMARY
LIST OF FIGURES

Figure A. Test Apparatus Schematic
Figure B. Smoke Mask Mounted For Testing On Human Head Simulator In Glove Box

I. Introduction

This is a report of the tests carried out on the XCAPER Personal Smoke Mask XSMO3 at the RNK Environmental, Inc. laboratory in Erlanger, Ky. from February 2007 to September 2008 for both gas and particulate removal. This testing was conducted to support the XCAPER application for certification of their smoke mask under the European Union standards program. The tests were carried out in a specially designed Plexiglas “glove box” chamber with a breathing human head simulator. In conducting the testing the EN403 test protocol was modified slightly to accommodate the vapor liquid extraction and dynamic filter media technology of the XCAPER smoke mask. Figure A presents a schematic of the test apparatus used in this testing.

The test gases and concentrations in EN403 were used to challenge the XCAPER smoke mask. The gases separately tested were carbon monoxide (CO), acrolein (C₃H₄O), hydrogen cyanide (HCN) and hydrogen chloride (HCl) along with particulates suspended in nitrogen (N₂). Each gas concentration and particulate concentration was certified by its supplier and confirmed by RNK Environmental, Inc. personnel. Figure B is a picture of the actual test apparatus used and shows a probe placed in the glove box to monitor the challenge gas concentration near the human head simulator.

II. Specific Objectives

1. To test the removal of carbon monoxide from ambient air by the smoke mask.
2. To test the removal of acrolein from ambient air by the smoke mask.
3. To test the removal of hydrogen cyanide from ambient air by the smoke mask.
4. To test the removal of hydrogen chloride from ambient air by the smoke mask.
5. To test the removal of particulates from ambient air by the smoke mask.
6. To conduct tests 15 minutes in duration.
7. To simulate real world breathing and conditions.
8. To develop a test protocol for dynamic media vapor liquid extraction filter technologies.
9. To test the smoke mask using air pollutant concentrations of: 30 x 10⁹ particles per cubic meter for particulates, 10 ppm acrolein, 100 ppm acrolein, 2,500 ppm carbon monoxide, 400 ppm for hydrogen cyanide, and 1,000 ppm for hydrogen chloride.

Figure A. Test Apparatus Schematic (Not-to-Scale)

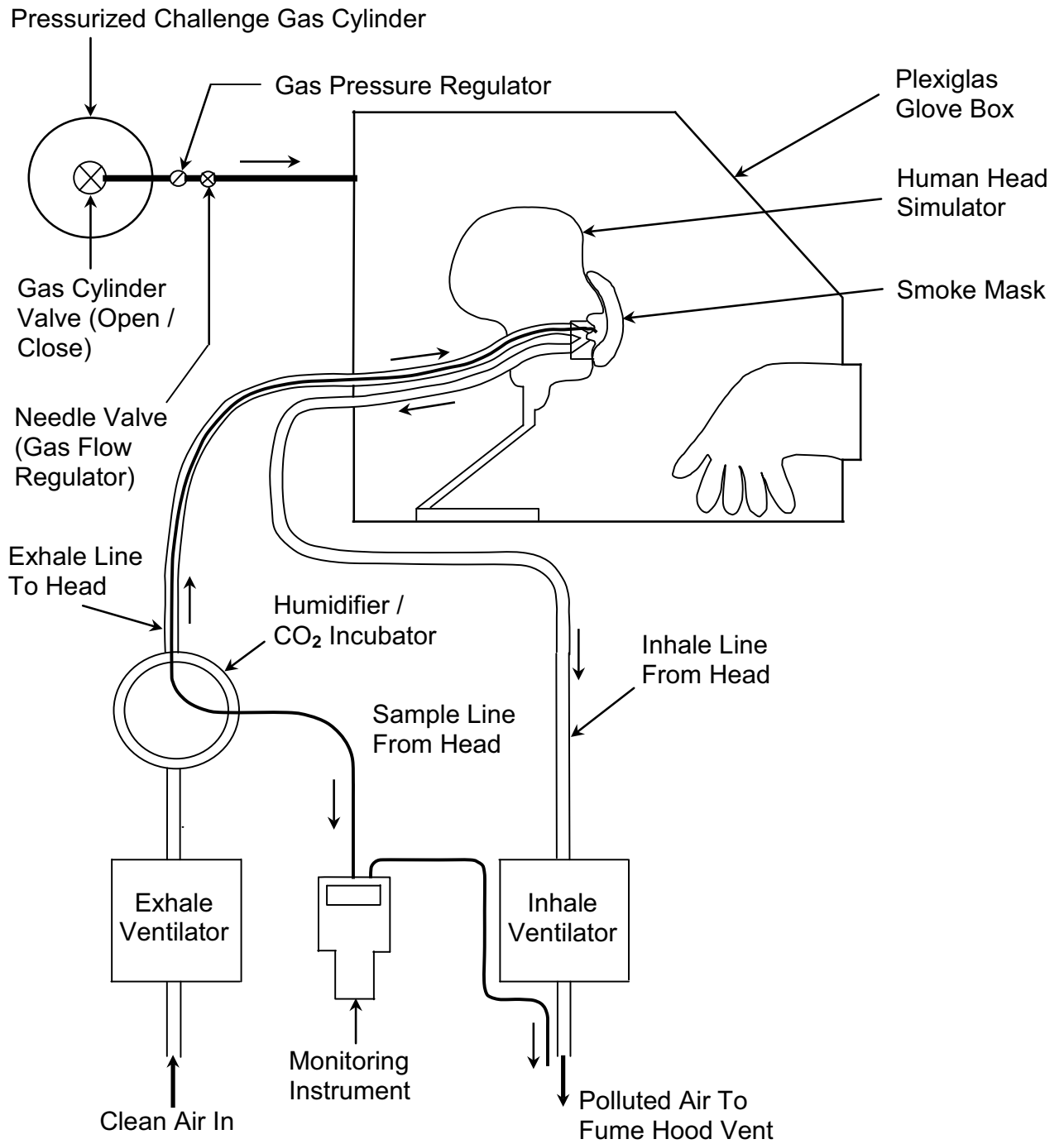



Figure B. Smoke Mask Mounted For Testing On Human Head Simulator In Glove Box

© RNK Environmental, Inc. 2007

III. Results

The XCAPER Personal Smoke Mask XSMO3 was tested. For each smoke mask and each challenge gas two tests were conducted. All of the smoke masks provided high degrees of removal over the 15-minute test period. Table A below presents a summary of the mean percent removals of all of the gases and particulates for the smoke mask type tested.

IV. Brief Discussion

The test protocol used in these studies was modified slightly from EN403 standards to support testing of dynamic media vapor liquid extraction technology. Test procedures were designed to simulate human respiration.

Each smoke mask tested was easy to mount on the simulated human head. Each smoke mask performed well over the entire 15-minute test period. Removals of gas were excellent for the 15-minute test period. Removals for particulates were near 100% for the 15-minute test period.

V. Summary

Each smoke mask tested removed large quantities of the target gas concentrations of 100 ppm acrolein, 400 ppm hydrogen cyanide, 1,000 ppm hydrogen chloride and 2,500 ppm carbon monoxide. Removal of 0.3 μm diameter particles at a concentration of 30×10^9 particles per cubic meter approached 100% for the 15-minute test period for each mask tested. Table A below presents a summary of the mean percent removals of all of the gases and particulates for the smoke mask type tested. The results indicate the smoke masks are useful in situations where these chemicals are introduced into the ambient air either accidentally such as in a fire setting or intentionally such as in a terrorist attack.

Table A. Mean Percent Removals For All Tests

| Challenge Mask Type | Particulates $30 \times 10^9 / \text{m}^3$ | Acrolein <u>10 ppm</u> | Acrolein <u>100 ppm</u> | CO <u>2,500 ppm</u> | HCN <u>400 ppm</u> | HCl <u>1,000 ppm</u> |
|------------------------|---|---------------------------|----------------------------|------------------------|-----------------------|-------------------------|
| Personal XSMO3 | 96.4% | 97.5% | 95.0% | 94.6% | 97.9% | 99.7% |

1. Introduction

This is a report of the tests carried out on the XCAPER Personal Smoke Mask XSMO3 at the RNK Environmental, Inc. laboratory in Erlanger, Ky. from February 2007 to September 2008 for both gas and particulate removal. This testing was conducted to support the XCAPER application for certification of their mask under the European Union standards program. The tests were carried out to simulate high breathing rates under stressful conditions in a specially designed Plexiglas “glove box” chamber with a breathing human head simulator. In conducting the testing the EN403 test protocol was modified slightly to accommodate the vapor liquid extraction and dynamic filter media technology of the XCAPER Personal Smoke Mask. Figure 1 presents a schematic diagram of the test apparatus used in this testing.

The challenge gases and concentrations in EN403 were used because there was no specific protocol for this type of smoke mask. The gases separately tested were carbon monoxide (CO), acrolein (C₃H₄O), hydrogen cyanide (HCN) and hydrogen chloride (HCl) along with particulates suspended in nitrogen (N₂). Each gas concentration and particulate concentration was certified by its supplier and confirmed by RNK Environmental, Inc. staff.

A specially designed Plexiglas glove box testing chamber was used for testing. Figure 2 presents a picture of the glove box showing an XCAPER smoke mask mounted on the human head simulator.

The breathing rate used was 30 l/min in accordance with EN403. The breathing volume was one liter. Figure 3 presents a picture of the test apparatus setup showing the glove box, human head simulator, and the hospital ventilators used. Monitoring methodologies and testing were consistent with EN403. Figure 4 presents a picture of the monitoring instrument being connected to the sample line in preparation for testing.

The EN403 standard does not currently support the dynamic media vapor liquid extraction technology used in the XCAPER Personal Smoke Mask. The XCAPER filter media is designed to shift within the smoke mask during use in response to the wearer’s body and facial movement. This continuously renews the microscopic surface layer of gas absorbing gel. This occurs several times per minute during actual use. To simulate this effect during testing a number of mechanical means were considered. None were judged to adequately simulate the media shifting effect. Ultimately the most effective and simplest means of simulating media shifting during testing was a light manual massage of the smoke mask conducted at one-minute intervals. Figure 5 is a picture showing a smoke mask being massaged during active testing.

2. Specific Objectives

1. To test the removal of 2,500 ppm carbon monoxide (CO) from ambient air by the smoke mask.
2. To test the removal of 400 ppm hydrogen cyanide (HCN) from ambient air by the smoke mask.
3. To test the removal of 10 ppm acrolein (C₃H₄O) from ambient air by the smoke mask.

4. To test the removal of 100 ppm acrolein (C_3H_4O) from ambient air by the smoke mask.
5. To test the removal of 1,000 ppm hydrogen chloride (HCl) from ambient air by the smoke mask.
6. To test the removal of particulates at a concentration of 30×10^9 particles per cubic meter from ambient air.
7. To conduct two tests 15 minutes in duration for each smoke mask against each challenge gas.
8. To simulate human respiration during testing.
9. To develop a test protocol for dynamic media vapor liquid extraction filter technologies.

3. Test Apparatus

1. A Plexiglas glove box test chamber.
2. A molded rubber human head simulator mounted on a metal pedestal.
3. A human breathing simulation system connected to the human head simulator with breathing tubes and consisting of: a) on the inhale side of a hospital breathing vent and b) on the exhale side a hospital breathing vent and a humidifier / CO_2 incubator.
4. A challenge gas delivery system consisting of: a) a pressurized cylinder containing the certified challenge gas and equipped with an open/close valve; b) a gas pressure regulator; c) a needle valve for regulating the flow of the challenge gas to the test chamber; and d) a challenge gas supply line leading to the test chamber.
5. A filtered gas sample line attached to the breathing zone of the human head simulator.
6. A monitoring instrument to analyze the concentration of the challenge gas behind the mask.

Figure 1. Test Apparatus Schematic Diagram (Not-to-Scale)

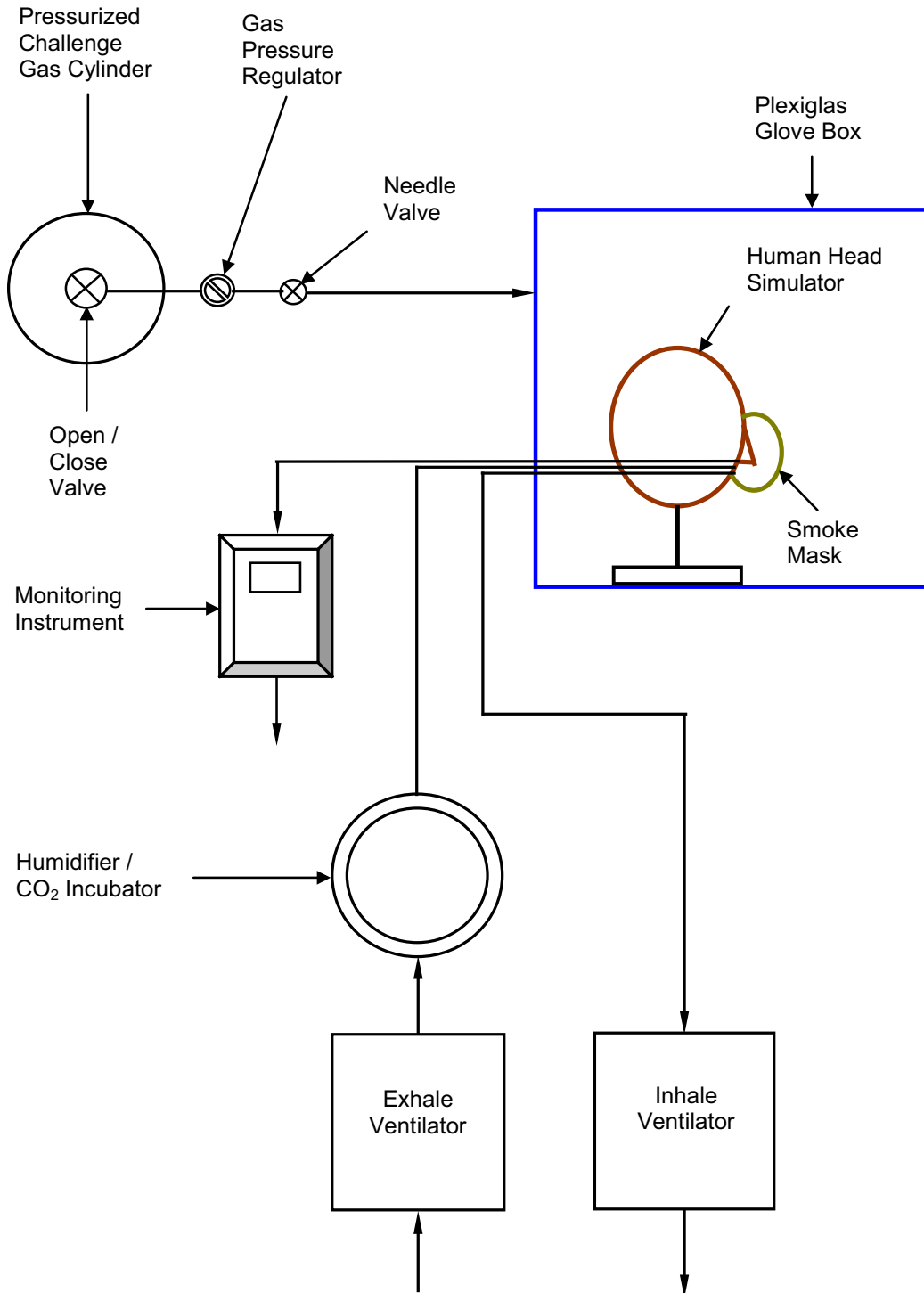



Figure 2. Smoke Mask Mounted on Human Head Simulator Inside Plexiglas Glove Box



Figure 3. Test Apparatus Setup With Head, Glove Box, and Hospital Ventilators

© RNK Environmental, Inc. 2007



Figure 4. Preparing For Testing By Connecting Monitoring Instrument to Sampling Line



Figure 5. Massaging a Smoke Mask During Active Test

© RNK Environmental, Inc. 2007

R N K ENVIRONMENTAL, INC.

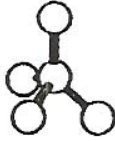

**2643 CRESCENT SPRINGS ROAD
ERLANGER, KY 41017
FAX / PHONE: (859) 344-0966**

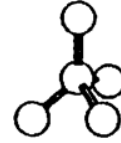

Riley N. Kinman, Ph.D., P.E., P.L.S., President
e-mail address: kinmanrn@email.uc.edu

XCAPER Smoke Mask Testing Project

Glove Box Chamber Test Procedure for Gases

1. Mount smoke mask to be tested on head. Record number of smoke mask.
2. Turn on exhale CO₂ incubator and heater for humidity (10 minutes).
3. Turn on monitoring instrument and calibrate.
4. Ensure smoke mask is secure on head.
5. Check all tubing for leaks.
6. Turn on gas at cylinder.
7. Adjust pressure to 10 psi.
8. Fill glove box chamber with gas.
9. Start test when glove box chamber reaches target gas concentration.
10. Read temperature and humidity in chamber.
11. Monitor challenge gas flow throughout test and adjust as needed.
12. Inhale vent on = start of test = time zero.
13. Exhale vent on 1 second later.
14. Read monitoring instrument for target gas at 1-minute intervals. See data sheet after smoke mask has cleared.
15. Massage smoke mask at 1-minute intervals to simulate wearer-smoke mask interactions.
16. Carry out test for 15 minutes.
17. Shut off gas to chamber.
18. Shut off instruments.
19. Ensure all data are collected and recorded on data sheet.
20. Sign data sheet.
21. Leave hood fans on until chamber is cleared.

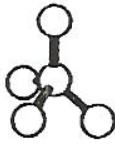

R N K ENVIRONMENTAL, INC.

**2643 CRESCENT SPRINGS ROAD
ERLANGER, KY 41017
FAX / PHONE: (859) 344-0966**

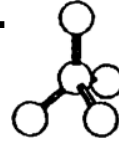

Riley N. Kinman, Ph.D., P.E., P.L.S., President
e-mail address: kinmanrn@email.uc.edu

XCAPER Smoke Mask Testing Project

Glove Box Chamber Test Procedure for Particulates

1. Mount smoke mask to be tested on head. Record number of smoke mask.
2. Turn on exhale CO₂ incubator and heater for humidity (10 minutes)
3. Turn on monitoring instrument and calibrate background.
4. Ensure smoke mask is secure on head.
5. Charge the particle reservoir chamber with particle to achieve the desired concentration of 30×10^9 particles per cubic meter
6. Start flow from the particle reservoir chamber to the glove box chamber.
7. Start test when glove box chamber reaches target particle concentration.
8. Read temperature and humidity in chamber.
9. Monitor particle flow throughout test and adjust as needed.
10. Inhale vent on = start of test = time zero.
11. Exhale vent on 1 second later.
12. Read instrument for particles/cm³ at 1-minute intervals. See data sheet.
13. Massage smoke mask at 1-minute intervals to simulate wearer-smoke mask interactions.
14. Carry out test for 15 minutes.
15. Shut off feed from particle reservoir chamber to glove box chamber.
16. Shut off exhale vent.
17. Shut off instruments.
18. Ensure all data are collected and recorded on data sheet.
19. Sign data sheet.
20. Leave hood fans on until chamber is cleared.

4. Results of Gas and Particulate Removal Testing

Table 1. lists the particular type and composition of XCAPER smoke mask that was tested in this current work effort.

Table 1. Type and Composition of Smoke Mask Tested

| <u>Mask Type</u> | <u>Mask Composition</u> |
|------------------|---------------------------|
| Personal XSMO3 | 13 oz. Beads 24 g. Gel |

At least two 15-minute runs were made on each smoke mask with the concentration recorded after each minute of breathing exposure. For each run 30 liters of the gas contaminants were passed through the smoke mask between readings that were recorded after the start of each test. All of the smoke masks generally provided a high degree of removal of the contaminants tested. Mean percent removals for all contaminants were above 90 percent and are discussed in more detail as follows.

Table 2. presents the percent removal results for each smoke mask for 10 ppm (+/- 10%) acrolein. Actual acrolein concentrations in the challenge gas were between 10.8 and 11.0 ppm. The data are based upon an assumed challenge gas concentration of 10 ppm. The test atmosphere was at a temperature of (20 ± 1) °C with a relative humidity of (70 ± 5) %. The XCAPER Personal Smoke Mask exhibited removals of 96.2 percent and 98.7 percent when challenged with 10 ppm acrolein. These results indicate that this type of mask provides a high degree of protection against acrolein at concentrations well above those found in residential or office fires.

Table 3. presents the percent removal results for each smoke mask for 100 ppm (+/- 10%) acrolein. Actual acrolein concentrations in the challenge gas were between 100 and 102 ppm. The data are based upon an assumed challenge gas concentration of 100 ppm. The test atmosphere was at a temperature of (20 ± 1) °C with a relative humidity of (70 ± 5) %. The XCAPER Personal Smoke Mask exhibited removals of 95.1 percent, 94.9 percent when challenged with 100 ppm acrolein. These results indicate that this type of mask provides a high degree of protection at a challenge gas concentration of 100 ppm acrolein.

Table 4. presents the percent removal results for each smoke mask for 1,000 ppm (+/- 10%) hydrogen chloride. Actual hydrogen chloride concentrations in the challenge gas were between 1,000 and 1,020 ppm. The data are based upon an assumed challenge gas concentration of 1,000 ppm. The test atmosphere was at a temperature of (20 ± 1) °C with a relative humidity of (30 ± 10) %. The XCAPER Personal Smoke Mask exhibited removals of 99.6 percent and 99.7 percent when challenged with 1,000 ppm hydrogen chloride. These results indicate that this type of mask provides a high degree of protection against the acid gas hydrogen chloride.

Table 5. presents the percent removal results for each smoke mask for 400 ppm (+/- 10%) hydrogen cyanide. Actual hydrogen cyanide concentrations in the challenge gas were between 400 and 408 ppm. The data are based upon an assumed challenge gas concentration of 400 ppm. The test atmosphere was at a temperature of (20 ± 1) °C with a relative humidity of (70 ± 5) %. The XCAPER Personal Smoke Mask exhibited removals of 97.8 and 97.9 percent when

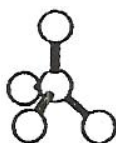

R N K ENVIRONMENTAL, INC.

2643 CRESCENT SPRINGS ROAD
 ERLANGER, KY 41017
 FAX / PHONE: (859) 344-0966

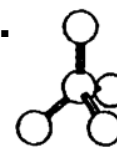

Riley N. Kinman, Ph.D., P.E., P.L.S., President
 e-mail address: kinmanrn@email.uc.edu

CONFIDENTIAL

XCAPER Industries, LLC

Summary of July 2007 Smoke Mask Testing
 Acrolein – 10 ppm

| <u>Date</u> | <u>Mask Type</u> | <u>Composition</u> | <u>Test Time (minutes)</u> | <u>Mean % Removal</u> |
|-------------|-------------------|-------------------------|----------------------------|-----------------------|
| 7/16/07 | Personal XSMO3 | 13 oz Beads 24 g Gel | 15 | 96.2 |
| 7/17/07 | Personal XSMO3 | 13 oz Beads 24 g Gel | 15 | 98.7 |

Table 2. Mean Percent Removals for 10 ppm Acrolein

XCAPER Industries, LLC

Summary of May 2007 Smoke Mask Testing
 Acrolein – 100 ppm

| <u>Date</u> | <u>Mask Type</u> | <u>Composition</u> | <u>Test Time (minutes)</u> | <u>Mean % Removal</u> |
|-------------|-------------------|-------------------------|----------------------------|-----------------------|
| 5/23/07 | Personal XSMO3 | 13 oz Beads 24 g Gel | 15 | 94.9 |
| 5/30/07 | Personal XSMO3 | 13 oz Beads 24 g Gel | 15 | 95.1 |

Table 3. Mean Percent Removals for 100 ppm Acrolein

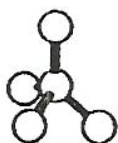

R N K ENVIRONMENTAL, INC.

2643 CRESCENT SPRINGS ROAD
 ERLANGER, KY 41017
 FAX / PHONE: (859) 344-0966

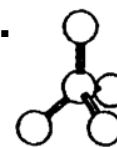

Riley N. Kinman, Ph.D., P.E., P.L.S., President
 e-mail address: kinmanrn@email.uc.edu

CONFIDENTIAL

XCAPER Industries, LLC
Summary of June 2007 Smoke Mask Testing
 Hydrogen Chloride (HCl) – 1,000 ppm

| <u>Date</u> | <u>Mask Type</u> | <u>Composition</u> | <u>Test Time (minutes)</u> | <u>Mean % Removal</u> |
|-------------|------------------|-------------------------|----------------------------|-----------------------|
| 6/12/07 | Personal XSMO3 | 13 oz Beads 24 g Gel | 15 | 99.6 |
| 6/12/07 | Personal XSMO3 | 13 oz Beads 24 g Gel | 15 | 99.7 |

Table 4. Mean Percent Removals for 1,000 ppm Hydrogen Chloride

XCAPER Industries, LLC
Summary of June 2007 Smoke Mask Testing
 Hydrogen Cyanide (HCN) – 400 ppm

| <u>Date</u> | <u>Mask Type</u> | <u>Composition</u> | <u>Test Time (minutes)</u> | <u>Mean % Removal</u> |
|-------------|------------------|-------------------------|----------------------------|-----------------------|
| 6/1/07 | Personal XSMO3 | 13 oz Beads 24 g Gel | 15 | 97.8 |
| 6/2/07 | Personal XSMO3 | 13 oz Beads 24 g Gel | 15 | 97.9 |

Table 5. Mean Percent Removals for 400 ppm Hydrogen Cyanide

challenged with 400 ppm hydrogen cyanide. These results indicate that this type of mask provides a high degree of protection at a challenge gas concentration of 400 ppm hydrogen cyanide.

Table 6. presents the percent removal results for each smoke mask for 2,500 ppm (+/- 10%) carbon monoxide. Actual carbon monoxide concentrations in the challenge gas were between 2,500 and 2,550 ppm. The data are based upon an assumed challenge gas concentration of 2,500 ppm. The temperature of the test atmosphere was (25 ± 1) °C with a relative humidity of 20.7 g/m³. The temperature of the exhaled air was (37 ± 1) °C with a relative humidity of 95 – 100%. The XCAPER Personal Smoke Mask exhibited removals of 93.8 percent, 95.5 percent and 94.4 percent when challenged with 2,500 ppm carbon monoxide. These results indicate that this type of smoke mask provides a high degree of protection against carbon monoxide.

Table 7. presents the percent removal results for each smoke mask for 0.3 µm diameter particulates suspended in nitrogen gas at a concentration of 30×10^9 particles per cubic meter. The XCAPER Personal Smoke Mask exhibited removals of 93.1 percent and 99.7 percent when challenged with particulates. These results indicate that this type of smoke mask provides a high degree of protection against particulates.

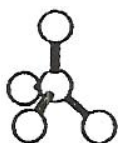

R N K ENVIRONMENTAL, INC.

2643 CRESCENT SPRINGS ROAD
 ERLANGER, KY 41017
 FAX / PHONE: (859) 344-0966

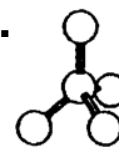

Riley N. Kinman, Ph.D., P.E., P.L.S., President
 e-mail address: kinmanrn@email.uc.edu

CONFIDENTIAL

XCAPER Industries, LLC
Summary of September 2008 Smoke Mask Testing
 CO – 2500 ppm

| <u>Date</u> | <u>Mask Type</u> | <u>Composition</u> | <u>Test Time (minutes)</u> | <u>Mean % Removal</u> |
|-------------|------------------|--------------------------|----------------------------|-----------------------|
| 9/4/08 | Personal XSMO3 | 13 oz Beads 24 oz Gel | 15 | 93.8 |
| 9/4/08 | Personal XSMO3 | 13 oz Beads 24 oz Gel | 15 | 95.5 |
| 9/4/08 | Personal XSMO3 | 13 oz Beads 24 oz Gel | 15 | 94.4 |

Table 6. Mean Percent Removals for 2,500 ppm Carbon Monoxide

XCAPER Industries, LLC
Summary of June 2007 Smoke Mask Testing
 0.3 µm Particles – 30 x 10⁹ / m³

| <u>Date</u> | <u>Mask Type</u> | <u>Composition</u> | <u>Test Time (minutes)</u> | <u>Mean % Removal</u> |
|-------------|------------------|-------------------------|----------------------------|-----------------------|
| 6/19/07 | Personal XSMO3 | 13 oz Beads 24 g Gel | 15 | 93.1 |
| 6/19/07 | Personal XSMO3 | 13 oz Beads 24 g Gel | 15 | 99.7 |

Table 7. Mean Percent Removals for 0.3 µm Particulates at 30 x 10⁹ particles per cubic meter

5. Procedures and Results for Physical Testing

5a. Breathing Resistance

Procedure

Breathing resistance testing of the XCAPER Personal Smoke Mask was conducted in accordance with BS EN 403:2004 & EN 143:2000. The same mounting procedure followed in the gas and particulate removal testing was used in conducting the breathing resistance tests. Test durations of both 30 and 60 minutes were used. Pressure readings were taken both inside and outside of the smoke mask per EN 403. The test results are expressed in millibars and are presented in the table below:

Breathing Resistance Results

| <u>Date</u> | <u>Mask Type</u> | Test Time (minutes) | Breathing Resistance | |
|-------------|-------------------|------------------------|----------------------|------------|
| | | | Inhale | Exhale |
| 4/29/08 | Personal XSMO3 | 30 | 0.95 mbars | 0.95 mbars |
| 4/29/08 | Personal XSMO3 | 60 | 0.95 mbars | 0.95 mbars |

The XCAPER Personal Smoke Mask passed the breathing resistance test. Pressure values measured were below the EN 403 standards of less than 8 millibars for inhale and less than 3 millibars for exhale.

5b. Flammability

Procedure

Flammability testing of the XCAPER Personal Smoke Mask was conducted in accordance with BS EN 13274-4:2001, Method 3. Prior to mounting the smoke mask on the test apparatus the propane burner was ignited and the flame height was adjusted to 40 millimeters (+/- 4 mm). The temperature at a point located 20 millimeters (+/- 2mm) above the burner tip was confirmed to be 800°C (+/- 50°C). The smoke mask was then mounted on the specimen support and adjusted such that the smoke mask being tested passed directly over tip of the propane burner when the support was rotated. The lowest part of the specimen was adjusted to leave a space of 20 millimeters (+/- 2 mm) between the tip of the burner and the smoke mask being tested. The speed of the rotator motor was adjusted to provide a linear speed of 60 millimeters per second (+/- 5 mm/sec). Each smoke mask tested was passed through the flame once at the speed of 60 millimeters per second (+/- 5 mm/sec) and was observed. The flammability test results are presented in the table below:

Flammability Results

| <u>Date</u> | <u>Mask Type</u> | Rotation Speed | Results |
|-------------|------------------|----------------|---------|
| 4/26/08 | Personal | 60 mm/sec | Passed |
| | XSMO3 | (+/- 5 mm/sec) | |
| 4/26/08 | Personal | 60 mm/sec | Passed |
| | XSMO3 | (+/- 5 mm/sec) | |

The XCAPER Personal Smoke Mask passed the flammability test. The smoke mask did not ignite under the terms and conditions of Method 3. It is not anticipated that the wearer would be exposed to any more severe conditions than those presented by the test. In actual use conditions there may be some evaporation of the moisture in the gel in proximity to heat. However, such evaporation would be minimal and would not prevent the mask from continuing to function in the normal manner.

Uncertainty

There should be no uncertainty in the test results unless by accident the aqueous gel was left out of the smoke mask during the manufacturing process. Absent the aqueous gel, the smoke mask would not perform its' other functions either. The aqueous gel must be present for the results of the flammability testing to be valid.

5c. Carbon Dioxide (Dead Space)**Procedure**

Dead space Carbon Dioxide testing of the XCAPER Personal Smoke Mask was conducted in accordance with BS EN 403:2004 & EN 136:1998. The same mounting procedure followed in the gas and particulate removal testing was used in conducting the dead space carbon dioxide tests. Carbon Dioxide concentrations were measured under dynamic conditions in the dead space of the breathing zone with the smoke mask mounted on the simulated human head. The breathing zone dead space carbon dioxide test results are presented in the table below:

Dead Space Carbon Dioxide Results

| <u>Date</u> | <u>Mask Type</u> | CO ₂ | | |
|-------------|------------------|-----------------|---------------|---------------|
| | | Measurement 1 | Measurement 2 | Measurement 3 |
| 4/27/08 | Personal | 355 ppm | 357 ppm | 333 ppm |
| | XSMO3 | 0.04% | 0.04% | 0.03% |

The XCAPER Personal Smoke Mask passed the dead space carbon dioxide test. The measured carbon dioxide values were all less than the standard of 0.1% carbon dioxide.

5d. Temperature of the Inhaled Air

In our breathing tests conducted in September 2008, the temperature of the test atmosphere was (25 ± 1) °C with a humidity of 20.7 g/m³ and the temperature of the exhaled air was (37 ± 1)

°C with a humidity of 95 – 100%. The dry bulb temperature of the inhaled air was measured using a fast response thermocouple and the moisture content of the inhaled air was measured continuously. The temperature of the inhaled air did not exceed 90 °C dry bulb and 50 °C wet bulb during the test duration of 15 minutes. The temperature of the inhaled air passing through the filter remained constant at (25 ± 1) °C indicating that the inhalation of carbon monoxide does not affect the temperature of inhaled air.

5e. Vision

The XCAPER Personal Smoke Mask was worn during a series of tasks such as preparing laboratory chemicals for use, conducting laboratory testing, and remediating mold infestations. No problems with vision were encountered and there were no alterations to the natural field of vision. The construction of the XCAPER Personal Smoke Mask is such that when the mask is worn virtually 100% of the natural field of vision is maintained.

5f. Practical Performance Test

Practical performance testing of the XCAPER Personal Smoke Mask was conducted in accordance with BS EN 403:2004(R), Sections 6.22 and 7.5. While wearing the smoke mask workers had no problems with communication when carrying out the activities in EN 403 as well as other activities. For example, one wearer treated an attic and crawl space of a house for mold infestation with no problems encountered in either carrying out the tasks or communicating with fellow workers outside of the restrictive setting. The attic had limited headspace and the crawl space was one meter under the house. In another example, two workers treated a mold infestation in a flooded basement without any problems encountered in carrying out the tasks or communicating. The results of the communication and practical performance testing are presented in the table below:

| <u>Practical Performance Test</u> | Temperature = 71°F | | | Humidity = 61% | |
|---|--------------------|-------|-------|----------------|-------|
| a) Harness Comfort: | | | | | |
| Subjects | 1) OK | 2) OK | 3) OK | 4) OK | 5) OK |
| b) Security of Fastenings and Couplings: | | | | | |
| Subjects | 1) OK | 2) OK | 3) OK | 4) OK | 5) OK |
| c) Accessibility of Controls: | | | | | |
| Subjects | 1) OK | 2) OK | 3) OK | 4) OK | 5) OK |
| d) Clarity of Vision (No visor or face piece): | | | | | |
| Subjects | 1) OK | 2) OK | 3) OK | 4) OK | 5) OK |
| e) The Visibility of a Sign Consisting of Letters 100 mm in Height at a Distance of 6m: | | | | | |
| Subjects | 1) OK | 2) OK | 3) OK | 4) OK | 5) OK |
| f) Communication with Test Supervisor: | | | | | |
| Subjects | 1) OK | 2) OK | 3) OK | 4) OK | 5) OK |

The XCAPER Personal Smoke Mask passed all communication and practical performance tests.

5g. Impact**Procedure**

Impact testing of the XCAPER Personal Smoke Mask was conducted in accordance with BS EN 403:2004, Section 7.4.3. Each mask was dropped in its packaging from a height of 1.5 meters onto a smooth concrete surface. XCAPER smoke masks are packaged in an aluminum foil pouch. The results of the impact testing are presented in the table below:

| <u>Date</u> | <u>Mask Type</u> | <u>Sample No.</u> | <u>Drop No.</u> | <u>Result</u> | <u>Observations</u> |
|-------------|-------------------|-------------------|-----------------|---------------|------------------------------|
| 5/21/08 | Personal XSMO3 | Sample 1 | 1 | Passed | No Damage |
| | | | 2 | Passed | No Damage |
| | | | 3 | Passed | Slight Ruffling of Foil Flap |
| | | | 4 | Passed | No Damage |
| | | | 5 | Passed | No Damage |
| | | | 6 | Passed | No Damage |
| 5/21/08 | Personal XSMO3 | Sample 2 | 1 | Passed | No Damage |
| | | | 2 | Passed | Slight Ruffling of Foil Flap |
| | | | 3 | Passed | No Damage |
| | | | 4 | Passed | No Damage |
| | | | 5 | Passed | No Damage |
| | | | 6 | Passed | No Damage |

The only change noted during the test was if the pouch landed on its' edge where it is sealed and forms a flap. In this case the impact would result in a slight ruffling of the foil flap but no damage to the pouch containing the mask. In any case no damage to either the packaging or the mask was caused from the impact testing of the XCAPER Personal Smoke Mask.

5h. Resistance of Packaging to Puncture and Tear**Procedure**

The XCAPER Personal Smoke Mask was subjected to the puncture and tear test procedures contained in BS EN 403:2004, Section 7.4.4. Each mask was struck in its packaging with a striker at a force of 1N +/-2% and observed for either punctures or tears. The results of the puncture and tear testing are presented in the table below:

| <u>Date</u> | <u>Mask Type</u> | <u>Sample No.</u> | <u>Strike No.</u> | <u>Result</u> | <u>Observations</u> |
|-------------|------------------|-------------------|-------------------|---------------|---------------------|
| 5/21/08 | Personal XSMO3 | Sample 1 | 1 | Passed | No puncture or tear |
| | | | 2 | Passed | No puncture or tear |
| | | | 3 | Passed | No puncture or tear |
| 5/21/08 | Personal XSMO3 | Sample 2 | 1 | Passed | No puncture or tear |
| | | | 2 | Passed | No puncture or tear |
| | | | 3 | Passed | No puncture or tear |
| 5/21/08 | Personal XSMO3 | Sample 3 | 1 | Passed | No puncture or tear |
| | | | 2 | Passed | No puncture or tear |
| | | | 3 | Passed | No puncture or tear |
| 5/21/08 | Personal XSMO3 | Sample 4 | 1 | Passed | No puncture or tear |
| | | | 2 | Passed | No puncture or tear |
| | | | 3 | Passed | No puncture or tear |

All of the packaging for the XCAPER Personal Smoke Mask passed the test for resistance to puncture and tear. No damage to either the packaging or the mask in regards to puncture or tear was observed in any of the tests.

6. Discussion

Simulation of the human breathing process is impossible to perform with 100% accuracy. At least 17 variables are involved in this breathing process with many of the variables being interdependent. In early testing conducted in 2003 to provide a suitable simulation, an initial protocol was established in which hospital breathing vent pumps were used to push challenge gases through the smoke mask placed on a human head simulator. Measurements were made in the nasal area between the mask and the human head simulator on a sample of gas that had passed through the smoke mask. In prior testing these measurements were used in determining and reporting percent removals.

In the current testing series covered in this report several refinements were made in the testing protocol in accordance with EN403 standards. The human head simulator was placed in a sealed glove box chamber that was filled with the challenge gas to be tested at the desired concentration. One hospital breathing vent was used to pull the challenge gas from the glove box chamber through the smoke mask into the nasal area between the smoke mask and the human head simulator while a second hospital breathing vent was to exhale out through the smoke mask one second later. Initial breathing rates of 38 liters per minute established in 2003 were adjusted to 30 liters per minute in accordance with EN403 standards. Gas from the breathing zone between the

human head simulator and the smoke mask was sampled continuously with measured concentrations out being recorded at one-minute intervals over the 15-minute test period. Using this refined protocol the current testing of the mask was carried out with the same challenge gases as in the 2003 testing but at different concentrations as specified in EN403.

The results using this refined protocol were similar to those obtained using the original protocol but the current test protocol and results are believed to be better and even more indicative of the utility of the smoke mask. This does not mean that this protocol absolutely duplicates human breathing. However, the refined protocol provides a simulation of human breathing sufficient to determine that the smoke mask should work well in offering short-term respiratory protection against the gases and particulates used in these tests. It should be noted that the dynamic media in the XCAPER Personal Smoke Mask shifts several times per minute during actual use. Simulated shifting of the media conducted by manually massaging the mask at one minute intervals results in slightly lower filtration performance than is experienced during actual use. We are continuing to study other options for more effectively simulating the body and facial movements during testing.

Table 8. below contains the mean results of all of the current testing for percent removal of the gas or particulates at the stated challenge concentration.

Table 8. Mean Percent Removals For All Tests

| Challenge Mask Type | Particulates $30 \times 10^9 / m^3$ | Acrolein <u>10 ppm</u> | Acrolein <u>100 ppm</u> | CO <u>2,500 ppm</u> | HCN <u>400 ppm</u> | HCl <u>1,000 ppm</u> |
|------------------------|--|---------------------------|----------------------------|------------------------|-----------------------|-------------------------|
| Personal XSMO3 | 96.4% | 97.5% | 95.0% | 94.6% | 97.9% | 99.7% |

Table 8. above indicates that the smoke mask tested should provide a high degree of short-term protection for the wearer in the presence of acid and toxic gases and particulates. This form of respiratory protection is easily placed into service in a short period of time over the nose and mouth by the prospective wearer. With instruction the prospective wearer should be able to don this type of smoke mask in less than 20 seconds.

7. Summary

The XCAPER Personal Smoke Mask XSMO3 was tested by challenging it with several toxic and acid gases typically produced by active and smoldering fires. The smoke mask was also challenged with simulated smoke particulates. The smoke mask was mounted on a human head simulator connected to hospital breathing vents in such a manner as to simulate human breathing under high activity and high stress situations. The human head simulator apparatus was mounted inside of a sealed Plexiglas glove box chamber into which the challenge gases were introduced at the desired concentrations. The smoke mask was challenged with 10 ppm acrolein, 100 ppm acrolein, 400 ppm hydrogen cyanide, 1,000 ppm hydrogen chloride, 2,500 ppm carbon monoxide and 0.3 µm diameter particles suspended in nitrogen at a concentration of 30×10^9 particles per cubic meter. Tested in this manner, the mask performed well in removing pollutants over the 15-minute test period with percent removals for each smoke mask being in the 90 to 100 percent range. The smoke mask was easy to mount on the head simulator and individuals that are provided with a small amount of training should be able to don this mask in less than 20 seconds.

Once in place the mask should provide a high degree of short-term respiratory protection against acid and toxic gases and smoke particulates that are typically generated from fires or smoldering fires.

So far removal data have been generated for carbon monoxide, hydrogen chloride, nitrous oxide (2003), nitrogen dioxide (2003), hydrogen cyanide, acrolein, and particulates for various configurations of the XCAPER Personal Smoke Mask during this and previous work conducted by RNK Environmental, Inc. In conducting the current testing the EN403 test protocol was modified slightly to accommodate the vapor liquid extraction and dynamic filter media technology of the XCAPER smoke mask. The methodology and protocols used for testing the masks as documented in this report are suitable for use by others in testing the XCAPER Personal Smoke Mask.